

WASTE SYSTEMS ACCESSORIES

ABFLUSSSYSTEME ZUBEHÖR

Protective cap for pipe

Schutzdeckel für Rohr



PP3 - TRIPLUS - BLACKFIRE - SILERE - HDPE

COD.	D	H	kg				HxLxP	CL	€/pz
VS0503033	50	30	0,008	50	800	4000	970x800x1200	CC01	0,66
VS0503015	75	29	0,018	30	480	2400	970x800x1200	CC01	0,76
VS0503017	90	30	0,022	30	240	1440	1000x800x1200	CC01	0,90
VS0503018	110	38,6	0,029	30	240	960	930x800x1200	CC01	1,09
VS0503019	125	39	0,036	20	160	960	1000x800x1200	CC01	1,36
VS0503031	160	49,5	0,062	10	80	320	930x800x1200	CC01	2,50

Firestop collar Tecnocollar

Tecnocollar

Brandschutzmanschette

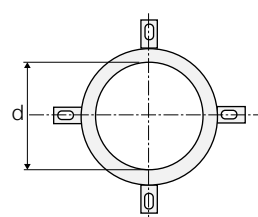

PP3 - TRIPLUS - BLACKFIRE - SILERE - HDPE

COD.	d Internal d innen	H height H Höhe	Nr. of fixing Anz. an Befestigungen	kg		CL	€/pz
VS0411051	32	50	4	0,098	5	CC01	24,75
VS0411053	40	50	4	0,129	5	CC01	25,69
VS0411055	55	50	4	0,159	5	CC01	26,10
VS0411057	63	50	4	0,163	5	CC01	29,43
VS0411059	75	50	4	0,214	5	CC01	31,51
VS0411061	82	50	4	0,220	5	CC01	32,03
VS0411063	90	50	4	0,266	5	CC01	36,19
VS0411065	110	50	4	0,355	10	CC01	40,66
VS0411067	125	60	4	0,655	5	CC01	61,67
VS0411069	140	60	4	0,775	1	CC01	73,04
VS0411071	160	60	4	1,180	10	CC01	82,68
VS0411073	200	75	6	1,259	1	CC01	264,16
VS0411075	250	75	6	1,715	1	CC01	341,12
VS0411077	315	75	6	2,494	1	CC01	455,52

Once the pipe has been installed, it is necessary to seal the pipe and hole on both sides of the wall or slab, using Tecno-S 240 acrylic silicone by Marvon S.r.l. (VS0411090).

Nach erfolgter Rohrverlegung muss an beiden Seiten der Wand oder des Boden der Bereich zwischen Rohr und Loch mit Acryl-Silikon Tecno-S 240 der Marvon S.r.l. abgedichtet werden. (VS0411090).

Accessories - Ersatzteile

Tecno-S 240 sealant

Dichtmittel Tecno-S 240



COD.	Conf.		CL	€/pz
VS0411090	310 ml	25	CC01	7,07

EQUIPMENT AND ACCESSORIES OF WASTE SYSTEMS
ABFLUSS-SYSTEME ZUBEHÖR

Collarwings fire stop collar EI 240

Collarwings
Brandschutzmanschette
EI 240

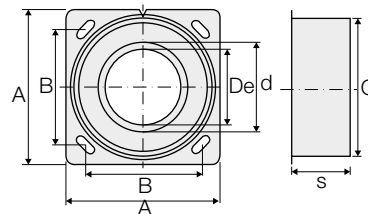

PP3 - TRIPLUS - BLACKFIRE - SILERE - HDPE

COD.	De (pipe - rohr)	d	A	B	C	s	kg		CL	€/pz
VS0411000	32	42	101	77	79	49,5	0,410	1	CC01	57,23
VS0411001	40	50	114	87	92	49,5	0,518	1	CC01	57,23
VS0411003	50	60	129	95	107	49,5	0,653	1	CC01	57,23
VS0411005	56-58	68	142	106	120	49,5	0,720	1	CC01	71,40
VS0411007	63	75	154	115	132	49,5	0,872	1	CC01	71,40
VS0411009	75	87	171	126	149	49,5	1,015	1	CC01	84,00
VS0411010	78-80	94	188	133	156	49,5	1,135	1	CC01	88,20
VS0411011	90	106	193	145	171	89,5	2,158	1	CC01	117,60
VS0411012	100	116	212	156	190	89,5	2,616	1	CC01	117,60
VS0411013	110	128	225	167	202	89,5	2,730	1	CC01	117,60
VS0411015	125	143	248	181	226	89,5	3,270	1	CC01	148,05
VS0411016	135	155	260	193	238	89,5	3,125	1	CC01	175,35
VS0411017	160	180	294	217	272	89,5	4,383	1	CC01	232,05

Fire collar EI 120

Brandschutzmanschette
EI 120

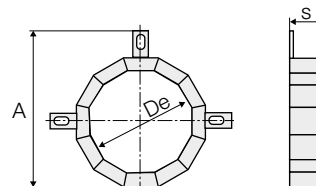

TRIPLUS - HDPE

COD.	D	DN	s	A	kg		CL	€/pz
VS0410019	200	200	177,5	257	4,148	1	CC01	460,72
VS0410021	250	250	232,5	319	6,578	1	CC01	686,40
VS0410023	315	300	330	395	13,470	1	CC01	1.392,00

Fire collar EI 180

Brandschutzmanschette
 EI 180

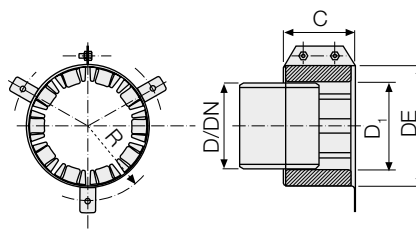

SILERE

COD.	D	DN	D ₁	DE	C	kg		CL	€/pz
VS0270005 •	58	50	65	95	80	0,313	1	SL02	120,31
VS0270007 •	78/90	70/90	95	140	80	0,764	1	SL02	158,65
VS0270013 •	135	125	144	195	110	1,140	1	SL02	217,47
VS0270015 •	160	150	166	215	120	1,228	1	SL02	234,62

• Sell out. - Ausverkauf.

PP vent cowl

Dunsthut (aus PP)

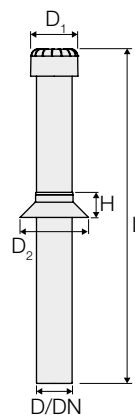

PP3 - TRIPLUS - BLACKFIRE - SILERE - HDPE

COD.	D	DN	D ₁	D ₂	L	H	kg				HxLxP	CL	€/pz
VS0394010	50	50	100	120	705	53	0,282	10	30	120	1090x800x1200	CC01	25,95
VS0394011	75	70	100	145	705	53	0,398	5	15	60	1105x800x1200	CC01	28,81
VS0394012	90	90	135	160	705	53	0,528	5	15	45	1105x800x1200	CC01	30,66
VS0394013	110	100	135	180	705	53	0,778	5	15	45	1200x800x1200	CC01	32,50

Air admittance valve

Belüfter

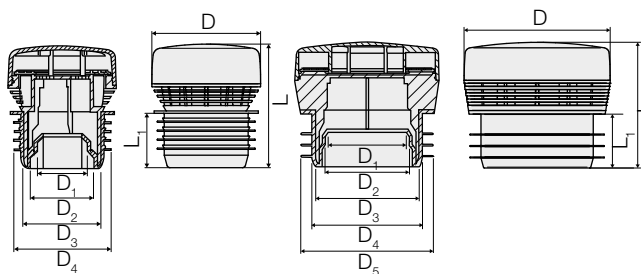

PP3 - TRIPLUS - BLACKFIRE - SILERE - HDPE

COD.	D	D ₁	D ₂	D ₃	D ₄	D ₅	L	L ₁	kg		CL	€/pz
VS0700401	70	32	40	50	63	-	79,5	35	0,102	12	SF01	49,58
VS0700402	125	70	75	90	100	110	108	46	0,358	6	SF01	91,35

EQUIPMENT AND ACCESSORIES OF WASTE SYSTEMS

ABFLUSS-SYSTEME ZUBEHÖR

M10 galvanized pipe clip with anchor, for fixed and sliding point

Verzinkte Schelle mit M10 - Spreizdübel, feste/ bewegliche Befestigung

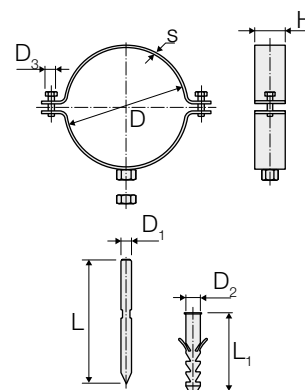

PP3 - TRIPLUS -BLACKFIRE - HDPE

COD.	D	H	D ₁ xL	D ₂ xL ₁	D ₃	s	kg		CL	€/pz
VS0395001	40	30	M10x120	12x60	M6	2,5	0,216	50	CC01	3,38
VS0395003	50	30	M10x120	12x60	M6	2,5	0,234	50	CC01	3,70
VS0395004	56	30	M10x120	12x60	M6	2,5	0,242	50	CC01	4,11
VS0395005	63	30	M10x120	12x60	M6	2,5	0,256	50	CC01	4,11
VS0395007	75	30	M10x120	12x60	M6	2,5	0,276	25	CC01	4,11
VS0395009	90	30	M10x120	12x60	M6	2,5	0,305	25	CC01	4,11
VS0395011	110	30	M10x120	12x60	M6	2,5	0,339	25	CC01	4,11
VS0395013	125	30	M10x120	12x60	M6	2,5	0,370	25	CC01	4,63
VS0395015	160	30	M10x120	12x60	M6	2,5	0,423	25	CC01	5,15

The clips are designed in order to allow fixed and sliding point installations by simply rotating the lower part of the clip itself by 180°. - Dank des Funktionsprinzips können durch einfaches Drehen des unteren Teils der Schelle um 180° sowohl feste, als auch bewegliche Befestigungspunkte realisiert werden.

M10 galvanized pipe clip, for fixed and sliding point

Verzinkte Schelle M10, feste/bewegliche Befestigung

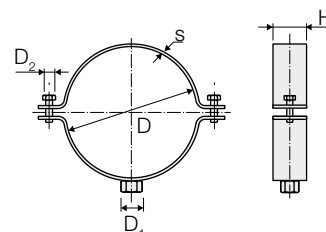

PP3 - TRIPLUS -BLACKFIRE - HDPE

COD.	D	D ₁	D ₂	H	s	kg		CL	€/pz
VS0396021	40	M10	M6	30	2,5	0,158	50	CC01	3,28
VS0396023	50	M10	M6	30	2,5	0,177	50	CC01	3,59
VS0396024	56	M10	M6	30	2,5	0,184	50	CC01	3,96
VS0396025	63	M10	M6	30	2,5	0,199	50	CC01	3,96
VS0396027	75	M10	M6	30	2,5	0,220	25	CC01	3,96
VS0396029	90	M10	M6	30	2,5	0,250	25	CC01	3,96
VS0396031	110	M10	M6	30	2,5	0,286	25	CC01	3,96
VS0396033	125	M10	M6	30	2,5	0,309	25	CC01	4,48
VS0396035	160	M10	M6	30	2,5	0,376	25	CC01	5,05

The clips are designed in order to allow fixed and sliding point installations by simply rotating the lower part of the clip itself by 180°. Dank des Funktionsprinzips können durch einfaches Drehen des unteren Teils der Schelle um 180° sowohl feste, als auch bewegliche Befestigungspunkte realisiert werden.

G1/2" and G1" galvanized pipe clip, for fixed and sliding point

Verzinkte Schelle G1/2"
und G1", feste/ bewegliche
Befestigung

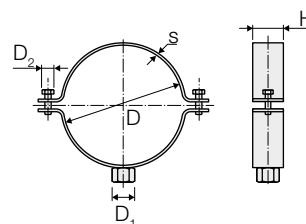

PP3 - TRIPLUS -BLACKFIRE - HDPE

COD.	D	D ₁	D ₂	H	s	kg		CL	€/pz
VS0396001 *	40	G1/2"	M6	30	2,5	0,176	50	CC01	3,28
VS0396003 *	50	G1/2"	M6	30	2,5	0,194	50	CC01	3,59
VS0396004 *	56	G1/2"	M6	30	2,5	0,208	50	CC01	3,96
VS0396005 *	63	G1/2"	M6	30	2,5	0,215	50	CC01	3,96
VS0396007 *	75	G1/2"	M6	30	2,5	0,240	25	CC01	3,96
VS0396009 *	90	G1/2"	M6	30	2,5	0,268	25	CC01	3,96
VS0396011 *	110	G1/2"	M6	30	2,5	0,308	25	CC01	3,96
VS0396013 *	125	G1/2"	M6	30	2,5	0,329	25	CC01	4,48
VS0396015 *	160	G1/2"	M6	30	2,5	0,394	25	CC01	5,05
VS0396050	200	G1"	M8	40	4	0,651	10	CC01	15,81
VS0396052	250	G1"	M8	40	4	1,270	10	CC01	16,95
VS0396054	315	G1"	M8	40	4	1,564	10	CC01	18,28

* The clips are designed in order to allow fixed and sliding point installations by simply rotating the lower part of the clip itself by 180°. -
Dank des Funktionsprinzips können durch einfaches Drehen des unteren Teils der Schelle um 180° sowohl feste, als auch bewegliche Befestigungspunkte realisiert werden.

M10 galvanized pipe clip with anchor and anti-vibration strip, for fixed and sliding point

Verzinkte Schelle mit
M10 - Spreizdübel und
Vibrationsschutz, feste/
bewegliche Befestigung

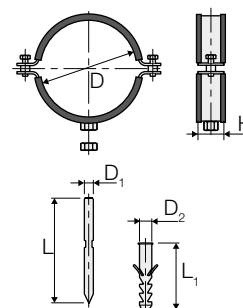

PP3 - TRIPLUS - BLACKFIRE - SILERE - HDPE

COD.	D	H	L	L ₁	D ₁	D ₂	Screw Schrauben	kg		CL	€/pz
VS0395021	40	30	120	75	M10	14	M6x20	0,236	50	CC01	4,92
VS0395022	50	30	120	75	M10	14	M6x20	0,260	50	CC01	5,09
VS0395023	56	30	120	75	M10	14	M6x20	0,281	50	CC01	5,36
VS0395024	58	30	120	75	M10	14	M6x20	0,277	50	CC01	5,36
VS0395025	63	30	120	75	M10	14	M6x20	0,291	50	CC01	5,63
VS0395026	75	30	120	75	M10	14	M6x20	0,318	25	CC01	6,07
VS0395027	78	30	120	75	M10	14	M6x20	0,309	25	CC01	6,07
VS0395028	90	30	120	75	M10	14	M6x20	0,354	25	CC01	6,66
VS0395029	110	30	120	75	M10	14	M6x20	0,399	25	CC01	6,76
VS0395030	125	30	120	75	M10	14	M6x20	0,439	25	CC01	7,62
VS0395031	135	30	120	75	M10	14	M6x20	0,469	25	CC01	8,17
VS0395032	160	30	120	75	M10	14	M6x20	0,522	25	CC01	9,30

EQUIPMENT AND ACCESSORIES OF WASTE SYSTEMS
ABFLUSS-SYSTEME ZUBEHÖR

M10 galvanized pipe clip with anti-vibration strip, for fixed and sliding point

Verzinkte Schelle M10 mit Vibrationsschutz, feste/bewegliche Befestigung

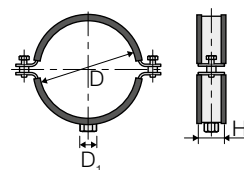

PP3 - TRIPLUS - BLACKFIRE - SILERE - HDPE

COD.	D	D ₁	H	kg		CL	€/pz
VS0396081	40	M10	30	0,179	50	CC01	4,06
VS0396082	50	M10	30	0,205	50	CC01	4,23
VS0396083	56	M10	30	0,219	50	CC01	4,55
VS0396084	58	M10	30	0,221	50	CC01	4,55
VS0396085	63	M10	30	0,234	50	CC01	4,82
VS0396086	75	M10	30	0,258	25	CC01	5,25
VS0396087	78	M10	30	0,253	25	CC01	5,25
VS0396088	90	M10	30	0,291	25	CC01	5,80
VS0396089	110	M10	30	0,346	25	CC01	5,90
VS0396090	125	M10	30	0,384	25	CC01	6,76
VS0396091	135	M10	30	0,407	25	CC01	7,62
VS0396092	160	M10	30	0,469	25	CC01	8,44

G1/2" and G1" galvanized pipe clip with anti-vibration strip, for fixed and sliding point

Verzinkte Schelle G1/2" und G1" mit Vibrationsschutz, feste/bewegliche Befestigung

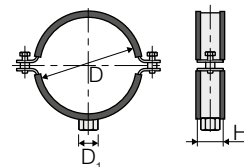

PP3 - TRIPLUS - BLACKFIRE - SILERE - HDPE

COD.	D	D ₁	H	kg		CL	€/pz
VS0396061	40	G1/2"	30	0,198	50	CC01	4,06
VS0396062	50	G1/2"	30	0,224	50	CC01	4,23
VS0396063	56	G1/2"	30	0,238	50	CC01	4,55
VS0396064	58	G1/2"	30	0,241	50	CC01	4,55
VS0396065	63	G1/2"	30	0,252	50	CC01	4,82
VS0396066	75	G1/2"	30	0,277	25	CC01	5,25
VS0396067	78	G1/2"	30	0,272	25	CC01	5,25
VS0396068	90	G1/2"	30	0,319	25	CC01	5,80
VS0396069	110	G1/2"	30	0,365	25	CC01	5,90
VS0396070	125	G1/2"	30	0,401	25	CC01	6,76
VS0396071	135	G1/2"	30	0,427	25	CC01	7,62
VS0396072	160	G1/2"	30	0,484	25	CC01	8,44
VS0396073	200	G1"	40	1,257	10	CC01	18,88
VS0396074	250	G1"	40	1,496	10	CC01	21,14
VS0396075	315	G1"	40	1,798	10	CC01	25,52

Galvanized steel flange for wall fixing

Fixierungsflansch

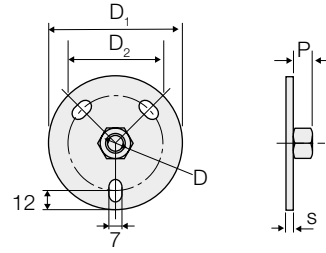

PP3 - TRIPLUS - BLACKFIRE - SILERE - HDPE

COD.	D	P	s	D ₁	D ₂	kg		CL	€/pz
VS0398001	G1/2"	15	4	70	50	0,141	100	CC01	2,62

This flange is used to secure the clips directly to the wall or ceiling. - Der Flansch dient zur Befestigung der Schellen direkt an der Wand oder Decke.

Galvanized steel plate for wall fixing

Verzinkter Stahlflansch für Wandbefestigung

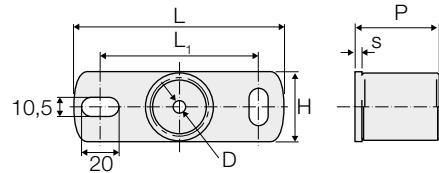

PP3 - TRIPLUS - BLACKFIRE - SILERE - HDPE

COD.	D	L	H	P	s	L ₁	kg		CL	€/pz
VS0398004	G1/2"	120	40	20	4	82	0,165	25	CC01	6,61
VS0398005	G1"	120	40	50	4	90	0,236	25	CC01	6,00
VS0398007	M10	80	30	13	2	52	0,060	25	CC01	3,09

M10 Threaded rod

Gewindestange M10

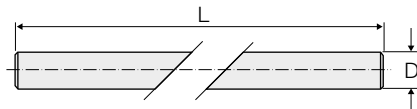

PP3 - TRIPLUS - BLACKFIRE - SILERE - HDPE

COD.	D	L	kg		CL	€/pz
VS0408001	M10	1000	0,418	1	CC01	2,87

Accessories - Ersatzteile

Anti-vibration strip for pipe clips

Schwingungsdämpfendes Einlegeband

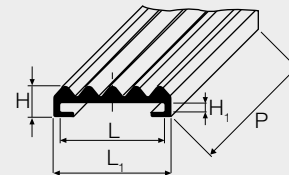

PP3 - TRIPLUS - BLACKFIRE - SILERE - HDPE

COD.	L	L ₁	H	H ₁	P (m)	kg		CL	€/pz
VS0399222	30	36	9	3	30	5,427	1	CC01	168,73
VS0399224	40	46	9	4	10	2,393	1	CC01	64,57

EQUIPMENT AND ACCESSORIES OF WASTE SYSTEMS
ABFLUSS-SYSTEME ZUBEHÖR

Back flow preventing valve with locking lever

Rückstauventil mit Verriegelung

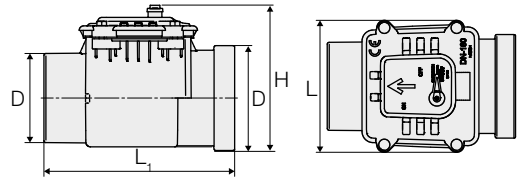

PP3 - TRIPLUS - BLACKFIRE - SILERE - HDPE

COD.	D	L	L ₁	H	kg		CL	€/pz
VS0200112	110	190	310	200	1,420	1	SF01	161,10
VS0200114	125	200	400	270	1,993	1	SF01	177,81
VS0200116	160	235	340	260	2,035	1	SF01	193,32
VS0200118	200	304	560	353	6,736	1	SF01	428,42

Spare parts - Ersatzteile

Single-lipped seal for back flow preventing valves

Einzellippendichtung für Rückstauventil

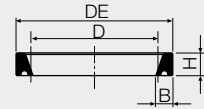

PP3 - TRIPLUS - BLACKFIRE - SILERE - HDPE

COD.	D	DN	DE	H	B	kg		CL	€/pz
VS0391015	110	100	123,9	8,9	7,9	0,020	20	CC01	0,63
VS0391017	125	125	142,2	10,2	8,9	0,029	20	CC01	0,99
VS0391019	160	150	179,8	11,5	10,2	0,046	20	CC01	1,30
VS0391021	200	200	223,7	12,8	11,2	0,079	20	CC01	2,29

EQUIPMENT OF WASTE SYSTEMS

ABFLUSSSYSTEME ZUBEHÖR

Thermal acoustic insulation for waste pipes

Thermische, schalldämmende Isolierung für Abflussrohre

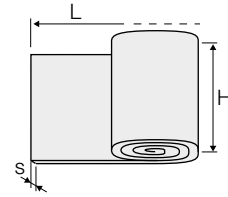

HDPE

COD.	Size - Abmessungen LxH	s	kg	(m ²)	CL	€/m ²
VS0399252	2000x1000	14	4,814	2	CC01	72,20

Is an open cell expanded polyurethane resin thickness 12 mm, density 30 kg/m³ self-extinguishing combined with a layer of loaded rubber fireproof GK weighing 4 kg/m² with a thickness of 2 mm. It does not contain bitumen and other noxious substances.

Diese Isolierung besteht aus einem offener Zellen expandierten Polyurethanharz: Dicke 12 mm, Dichte 30 kg selbstverlöschendes UL94 HF1 verbunden mit einer Schicht aus Flammenschutzgummi GK mit Mineralienzusatz 4 kg/m² Dicke 2 mm. Das Produkt ist selbstverlöschend und besteht aus Gummipolymeren mit Mineralienzusatz. Produkt frei von Blei, Cadmium, Bitumen oder anderen Schadstoffen. Abmessung 2000x1000 mm.

Welding plate with steel box

Schweißspiegel mit Metallkoffer



HDPE

COD.	For pipes - Für rohr D	kg		CL	€/pz
VS0450001	40÷160	6,293	1	ATPE	480,55
VS0450003	110÷300	11,903	1	ATPE	813,26

MOD. VR 160 JOYT Portable butt-welding machine with special clamps for branches and bends

Tragbares Schweissgerät ausgerüstet mit speziellen Schraubstöcken für Verbindungsrohre und Bögen



HDPE

COD.	D	kg		CL	€/pz
VS0468165	40÷160	102,800	1	ATPE	6.984,97

This item does not include reducers and side supports D 56. - *Der Artikel umfasst nicht die Reduzierungen und seitlichen Halterungen D 56.*

EQUIPMENT AND ACCESSORIES OF WASTE SYSTEMS
ABFLUSS-SYSTEME ZUBEHÖR

Spare parts - Ersatzteile

Spare blades for shaving mill

Ersatzklingen

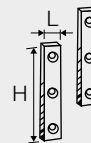

HDPE

COD.	H	L	kg		CL	€/pz
VS0477510	75	12	0,020	1	ATPE	292,20

For code - Für ART.-NR. VS0468165.

Driving belt

Antriebsriemen



HDPE

COD.	kg		CL	€/pz
VS0477550	0,050	1	ATPE	29,74

For code - Für ART.-NR. VS0468165.

Pipe lateral support reducing bracket

Reduzierung- seitlicher Halter



HDPE

COD.	D	kg		CL	€/pz
VS0477303	40	0,170	1	ATPE	23,20
VS0477305	50	0,169	1	ATPE	23,20
VS0477306	56	0,162	1	ATPE	23,20
VS0477307	63	0,173	1	ATPE	23,20
VS0477309	75	0,150	1	ATPE	23,20
VS0477311	90	0,139	1	ATPE	23,20
VS0477313	110	0,123	1	ATPE	23,20
VS0477315	125	0,099	1	ATPE	23,20

Spare parts - Ersatzteile

Clamp reducer

Reduzierung-seitlicher Gegenhalter



HDPE

COD.	D	Mod.	kg		CL	€/pz
VS0477260	40	inferior - niedrig	0,720	1	ATPE	23,42
VS0477261	50	inferior - niedrig	0,720	1	ATPE	23,42
VS0477262	56	inferior - niedrig	0,720	1	ATPE	23,42
VS0477263	63	inferior - niedrig	0,720	1	ATPE	23,42
VS0477264	75	inferior - niedrig	0,720	1	ATPE	23,42
VS0477265	90	inferior - niedrig	0,720	1	ATPE	23,42
VS0477266	110	inferior - niedrig	0,720	1	ATPE	23,42
VS0477267	125	inferior - niedrig	0,720	1	ATPE	23,42
VS0477268	160	inferior - niedrig	0,720	1	ATPE	23,42
VS0477270	40	superior - hoch	0,720	1	ATPE	23,42
VS0477271	50	superior - hoch	0,720	1	ATPE	23,42
VS0477272	56	superior - hoch	0,720	1	ATPE	23,42
VS0477273	63	superior - hoch	0,720	1	ATPE	23,42
VS0477274	75	superior - hoch	0,720	1	ATPE	23,42
VS0477275	90	superior - hoch	0,720	1	ATPE	23,42
VS0477276	110	superior - hoch	0,720	1	ATPE	23,42
VS0477277	125	superior - hoch	0,720	1	ATPE	23,42
VS0477278	160	superior - hoch	0,720	1	ATPE	23,42

Lateral support

Seitenhalterung für Schweißgeräte



HDPE

COD.	kg		CL	€/pz
VS0478160	0,235	1	ATPE	54,62

For code - Für ART.-NR. VS0468165.

EQUIPMENT AND ACCESSORIES OF WASTE SYSTEMS
ABFLUSS-SYSTEME ZUBEHÖR

MOD. SUPER

Portable butt welding machine

Tragbares Schweissgerät



HDPE

COD.	D	kg		CL	€/pz
VS0470001	75÷250	83,000	1	ATPE	8.277,48

Spare parts - Ersatzteile

Spare blades

Ersatzklingen

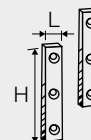

HDPE

COD.	H	L	kg		CL	€/pz
VS0477525	130	15	0,045	1	ATPE	103,02

Driving belt

Antriebsriemen



HDPE

COD.	kg		CL	€/pz
VS0477520	0,061	1	ATPE	18,61

MOD. MAXI

**Welding machine
 with carriage**

Schweissgerät mit
 Transportwagen



HDPE

COD.	D	kg		CL	€/pz
VS0470005	90÷315	217,900	1	ATPE	16.480,34

Spare parts - Ersatzteile

Spare blades

Ersatzklingen

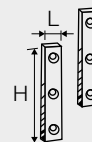

HDPE

COD.	H	L	kg		CL	€/pz
VS0477535	160	20	0,098	1	ATPE	145,96

Driving belt

Antriebsriemen



HDPE

COD.	kg		CL	€/pz
VS0477540	0,050	1	ATPE	42,05

EQUIPMENT AND ACCESSORIES OF WASTE SYSTEMS
ABFLUSS-SYSTEME ZUBEHÖR

**Valsir electrofusion
welding machine
40-160 V2**

Valsir Elektromuffen-
Schweissgerät
40-160 V2



HDPE

COD.	D	kg		CL	€/pz
VS0464010	40÷160	3,365	1	ATPE	939,70

Available from 05/2021. - Verfügbar ab 05/2021.

**Valsir electrofusion
welding machine
40-160 V1**

Valsir Elektromuffen-
Schweissgerät
40-160 V1



HDPE

COD.	D	kg		CL	€/pz
VS0464001 •	40÷160	3,240	1	ATPE	939,70

• Sell out. - Ausverkauf.

Spare parts - Ersatzteile

**Cable and plugs for Valsir
40-160 V1 electric welding
machine**

Kabel und Stecker für elektri-
sche Muffenschweißmaschine
Valsir 40-160 V1



HDPE

COD.	kg		CL	€/pz
VS0464222	0,308	1	ATPE	118,74

For code - Für ART.-NR. VS0464001.

**Valsir universal
 electrofusion welding
 machine**

*Valsir Elektromuffen-
 Schweissgerät universal*



HDPE

COD.	D	kg		CL	€/pz
VS0464333	40÷315	5,357	1	ATPE	2.025,84
VS0464331 ©	40÷315	4,877	1	ATPE	2.025,84

© Switzerland. - Modell für die Schweiz.

Spare parts - Ersatzteile

**Power cable for
 Switzerland**

Netzanschlusskabel Modell CH



HDPE

COD.	Version - Schweissausführung	kg		CL	€/pz
VS0464431	universal S (mod. 2012)	0,782	1	ATPE	177,11

Universal power cable

Netzanschlusskabel universal



HDPE

COD.	Version - Schweissausführung	kg		CL	€/pz
VS0464433	universal S (mod. 2012)	0,764	1	ATPE	177,11

Universal lead for plugs

*Universal Anschlusskabel
 Steckerstifte*



HDPE

COD.	Version - Schweissausführung	kg		CL	€/pz
VS0464435	universal S (mod. 2012)	0,769	1	ATPE	200,74
VS0464436	universal V1	0,643	1	ATPE	200,74

EQUIPMENT AND ACCESSORIES OF WASTE SYSTEMS
ABFLUSS-SYSTEME ZUBEHÖR

Spare parts - Ersatzteile

Plugs

Steckerstifte



HDPE

COD.	D	Colour Farbe	Version Schweissausführung	kg		CL	€/pz
VS0464334	40÷160	yellow - <i>Gelb</i> A00	universal S (mod. 2012)	0,103	1	ATPE	237,31
VS0464338	40÷160	yellow - <i>Gelb</i> A00	universal V1	0,102	1	ATPE	237,31
VS0464335	200÷315	blue - <i>Blau</i> A01	universal S (mod. 2012)	0,101	1	ATPE	237,31
VS0464339	200÷315	blue - <i>Blau</i> A01	universal V1	0,100	1	ATPE	237,31
VS0464336	200÷315	red - <i>Rot</i> A02	universal S (mod. 2012)	0,107	1	ATPE	237,31
VS0464340	200÷315	red - <i>Rot</i> A02	universal V1	0,107	1	ATPE	237,31
VS0464337	40÷160	green - <i>Grün</i> A03	universal S (mod. 2012)	0,075	1	ATPE	237,31
VS0464341 •	40÷160	green - <i>Grün</i> A03	universal V1	0,102	1	ATPE	237,31

• Sell out. - *Ausverkauf.*

Hot air blower

Automatisches
Heißluftgebläse



PP3 - HDPE

COD.	Watt	kg		CL	€/pz
VS0476001	700	1,789	1	CC01	906,28

Pipe scraper

Rohrschaber



HDPE

COD.	kg		CL	€/pz
VS0465333	0,092	1	ATPE	23,80

Pipe cutter

Rohrabschneider



PP3 - TRIPLUS - BLACKFIRE - SILERE - HDPE

COD.	D	Mod.	kg		CL	€/pz
VS0458011	6÷76	T1	0,550	1	CC01	175,32
VS0458003	50÷140	T2	1,309	1	CC01	252,50
VS0458005	100÷168	T3	1,384	1	CC01	312,48

Spare parts - Ersatzteile

Spare blades

Ersatzklingen



PP3 - TRIPLUS - BLACKFIRE - SILERE - HDPE

COD.	D	kg		CL	€/pz
VS0459001 •	6÷63	0,006	1	CC01	36,81
VS0459011	6÷76	0,006	1	CC01	30,66
VS0459003	50÷168	0,025	1	CC01	46,29

• Sell out. - Ausverkauf.

Pipe cutter

Rohrabschneider



TRIPLUS - HDPE

COD.	D	Mod.	kg		CL	€/pz
VS0458007	180÷318	T4	12,600	1	CC01	1.762,80

Spare parts - Ersatzteile

Spare blades

Ersatzklingen



TRIPLUS - HDPE

COD.	D	kg		CL	€/pz
VS0459007	180÷318	0,017	1	CC01	91,52

EQUIPMENT AND ACCESSORIES OF WASTE SYSTEMS

ABFLUSS-SYSTEME ZUBEHÖR

Beveling tool

Rohranfasgerät



PP3 - TRIPLUS - BLACKFIRE - SILERE - HDPE

COD.	D	kg		CL	€/pz
VS0460001	32÷160	0,803	1	CC01	220,11
VS0460003	40÷250	1,385	1	CC01	363,74

Spare parts - Ersatzteile

Spare blades

Ersatzklingen



PP3 - TRIPLUS - BLACKFIRE - SILERE - HDPE

COD.	D	H	L	kg		CL	€/pz
VS0460110	32÷160	32	13	0,025	1 pair - Paar	CC01	82,79
VS0460111	40÷250	34	12	0,025	1 pair - Paar	CC01	86,96

Steel cup miller

Stahltopffräser



HDPE

COD.	D	Connections Anschlüsse	kg		CL	€/pz
VS0465001	33	40	0,323	1	ATPE	120,49
VS0465003	43	50	0,343	1	ATPE	120,49

Chamfering knife

Messer



HDPE

COD.	kg		CL	€/pz
VS0473001	0,027	1 (12 pcs)	ATPE	178,46

Permanent pens

Markierstift



PP3 - HDPE

COD.	kg		CL	€/pz
VS0474001	0,117	1 (12 pcs)	CC01	71,44

Strip for welding

Reparatur-Schweisstäbe



PP3 - HDPE

COD.	Mat.	L (cm)	mm	kg		CL	€/pz
VS0477001	HDPE	100	5,5x3	2,006	1 (2 kg)	ATPE	96,80
VS0477003	PP	100	5,5X3	2,007	1 (2 kg)	ATPP	124,38

Lubricant

Gleitmittel



PP3 - TRIPLUS - BLACKFIRE - SILERE - HDPE

COD.	g	kg		CL	€/pz
VS0900001	150	0,161	50	CC01	2,55
VS0900003	250	0,269	50	CC01	3,07
VS0900005	1000	1,000	1	CC01	9,86
VS0900007	5000	5,00	1	CC01	45,64

